

MICTEC<sup>®</sup>

instruments  
for plastic and aesthetic  
surgery

DUFNER<sup>®</sup>

Instruments



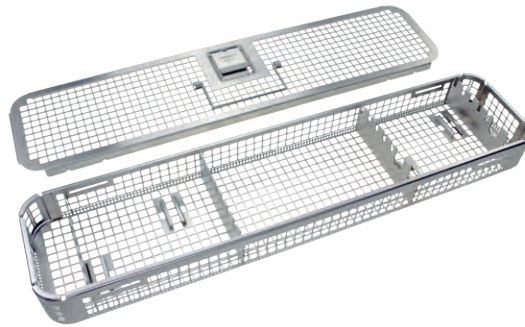

**46943-51**

Metall Steriliserbox für Saugkanülen mit Deckel, Maße 455 x 106 x 43 mm

Metal sterilization box for suction cannulas with cover, dimensions 455 x 106 x 43 mm



**46943-57**

MICTEC Liposuktionshandgriff mit Clicasept Adapter, mit Saugstop

MICTEC Liposuction hand grip with Clicasept connector, with suction stop



**46973-64**

MICTEC Absaugkanüle mit Clicasept Adapter, Ø 3 mm, 24 Bohrungen zirkulär, 5 cm Arbeitshub, 250 mm Arbeitslänge

MICTEC Liposuction cannula with Clicasept connector, Ø 3 mm, 24 holes circular, 5 cm working capacity, 250 mm working length

**46973-66**

Ø 3 mm, 24 Bohrungen zirkulär, 6 cm Arbeitshub, 300 mm Arbeitslänge

Ø 3 mm, 24 holes circular, 6 cm working capacity, 300 mm working length

**46973-68**

Ø 3 mm, 24 Bohrungen zirkulär, 6 cm Arbeitshub, 350 mm Arbeitslänge

Ø 3 mm, 24 holes circular, 6 cm working capacity, 350 mm working length

**46973-76**

Ø 3 mm, 12 Bohrungen semizirkulär, 4 cm Arbeitshub, 150 mm Arbeitslänge

Ø 3 mm, 12 holes semi circular, 4 cm working capacity, 150 mm working length

**46973-78**

Ø 3 mm, 12 Bohrungen semizirkulär, 4 cm Arbeitshub, 200 mm Arbeitslänge

Ø 3 mm, 12 holes semi circular, 4 cm working capacity, 200 mm working length

**46973-80**

Ø 3 mm, 12 Bohrungen semizirkulär, 5 cm Arbeitshub, 250 mm Arbeitslänge

Ø 3 mm, 12 holes semi circular, 5 cm working capacity, 250 mm working length

**Weitere Abmessungen und Modelle auf Anfrage. Alle Kanülen auch als Luer-Version lieferbar.**

**Please ask for further dimensions and models. All cannulas are also available with Luer connector.**



**46953-01**

Zwischenadapter für die Verwendung von Luer-Lock-Kanülen auf unseren Clicasept-Handgriffen

Connector to use Luer-Lock cannulas on our Clicasept hand grips



**46944-80-224**

MICTEC Absaugkanüle mit Clicasept Adapter, Ø 4 mm, 120° spiralförmig, flache Spitze, 2 Spiralen, 240 mm Arbeitslänge

MICTEC Liposuction cannula with Clicasept connector, Ø 4 mm, 120° spiral shaped, flat tip, 2 spirals, 240 mm working length

**46944-80-324**

3 Spiralen, 240 mm Arbeitslänge

3 spirals, 240 mm working length

**46944-80-228**

2 Spiralen, 280 mm Arbeitslänge

2 spirals, 280 mm working length

**46944-80-328**

3 Spiralen, 280 mm Arbeitslänge

3 spirals, 280 mm working length



**46944-81-224**

MICTEC Absaugkanüle mit Clicasept Adapter, Ø 3 mm, 120° spiralförmig, flache Spitze, 2 Spiralen, 240 mm Arbeitslänge

MICTEC Liposuction cannula with Clicasept connector, Ø 3 mm, 120° spiral shaped, flat tip, 2 spirals, 240 mm working length

**46944-81-324**

3 Spiralen, 240 mm Arbeitslänge

3 spirals, 240 mm working length

**46944-81-228**

2 Spiralen, 280 mm Arbeitslänge

2 spirals, 280 mm working length

**46944-81-328**

3 Spiralen, 280 mm Arbeitslänge

3 spirals, 280 mm working length



**46944-83-324**

MICTEC Mercedes-Absaugkanüle mit Clicasept Adapter, Ø 3 mm, runde Spitze, 240 mm Arbeitslänge

MICTEC Mercedes Liposuction cannula with Clicasept connector, Ø 3 mm, round tip, 240 mm working length

**46944-83-328**

Ø 3 mm, 280 mm Arbeitslänge

Ø 3 mm, 280 mm working length



**46944-83-424**

Ø 4 mm, 240 mm Arbeitslänge

Ø 4 mm, 240 mm working length

**46944-83-428**

Ø 4 mm, 280 mm Arbeitslänge

Ø 4 mm, 280 mm working length



**46974-50**

MICTEC Absaugkanüle mit Clicasept Adapter, Ø 3 mm, 360° spiralförmig, flache Spitze, 150 mm Arbeitslänge

MICTEC Liposuction cannula with Clicasept connector, Ø 3 mm, 360° spiral shaped, flat tip, 150 mm working length

**46974-52**

Ø 3 mm, 250 mm Arbeitslänge

Ø 3 mm, 250 mm working length

**46974-62**

Ø 4 mm, 250 mm Arbeitslänge

Ø 4 mm, 250 mm working length

**Weitere Abmessungen und Modelle auf Anfrage. Alle Kanülen auch als Luer-Version lieferbar.**

**Please ask for further dimensions and models. All cannulas are also available with Luer connector.**



**46944-90-215**

MICTEC Absaugkanüle für den Halsbereich, mit Clicasept Adapter, Ø 2,5 mm, 4 Langlöcher seitlich, 1 konisches Langloch mittig, flache Spitze, 150 mm Arbeitslänge

MICTEC Liposuction cannula for neck, with Clicasept connector, Ø 2.5 mm, 4 long holes lateral, 1 conical hole concentric, flat tip, 150 mm working length



**46944-92-150**

MICTEC Absaugkanüle mit Clicasept Adapter, Ø 2,0 mm, amerikanisches Modell, konische Spitze, 1 Langloch, 28 Bohrungen, 150 mm Arbeitslänge

MICTEC Liposuction cannula with Clicasept connector, Ø 2.0 mm, american model, conical tip, 1 long hole, 28 holes, 150 mm working length



**46943-58**

MICTEC Infiltrationshandgriff mit Clicasept Adapter

MICTEC Infiltration hand grip with Clicasept connector



**46944-82-001**

MICTEC Infiltrationskanüle mit Clicasept Adapter, Ø 2,5 mm, runde Spitze, 240 mm Arbeitslänge

MICTEC Infiltration cannula with Clicasept connector, Ø 2.5 mm, round tip, 240 mm working length

**46944-82-002**

MICTEC Infiltrationskanüle mit Clicasept Adapter, Ø 2,5 mm, runde Spitze, 280 mm Arbeitslänge

MICTEC Infiltration cannula with Clicasept connector, Ø 2.5 mm, round tip, 280 mm working length



**46944-82-005**

MICTEC Infiltrationskanüle mit Clicasept Adapter, Ø 2,0 mm, runde Spitze, 240 mm Arbeitslänge

MICTEC Infiltration cannula with Clicasept connector, Ø 2.0 mm, round tip, 240 mm working length

**46944-82-006**

MICTEC Infiltrationskanüle mit Clicasept Adapter, Ø 2,0 mm, runde Spitze, 280 mm Arbeitslänge

MICTEC Infiltration cannula with Clicasept connector, Ø 2.0 mm, round tip, 280 mm working length

**Auch in Luer-Lock Ausführung lieferbar.**

**Luer-Lock version also available.**



	<b>12-06120-19</b>	MICTEC Handgriff ohne Loch für MICTEC Absaugkanülen mit Gewindeadapter	Handle without hole for MICTEC Liposuction cannulas with thread adapter
	<b>12-06120-20</b>	Schlauch-Olive für MICTEC Handgriff ohne Loch 12-06120-19	Tube connection for MICTEC handle without hole 12-06120-19
	<b>46944-84-215</b>	MICTEC Mercedes-Absaugkanüle mit Gewindeadapter, Ø 2,5 mm, 150 mm Arbeitslänge	MICTEC Mercedes Liposuction cannula with thread adapter, Ø 2.5 mm, 150 mm working length
	<b>46944-84-325</b>	MICTEC Mercedes-Absaugkanüle mit Gewindeadapter, Ø 3,0 mm, 250 mm Arbeitslänge	MICTEC Mercedes Liposuction cannula with thread adapter, Ø 3.0 mm, 250 mm working length
	<b>46944-84-335</b>	MICTEC Mercedes-Absaugkanüle mit Gewindeadapter, Ø 3,0 mm, 350 mm Arbeitslänge	MICTEC Mercedes Liposuction cannula with thread adapter, Ø 3.0 mm, 350 mm working length
	<b>46944-84-425</b>	MICTEC Mercedes-Absaugkanüle mit Gewindeadapter, Ø 4,0 mm, 250 mm Arbeitslänge	MICTEC Mercedes Liposuction cannula with thread adapter, Ø 4.0 mm, 250 mm working length
	<b>46944-84-435</b>	MICTEC Mercedes-Absaugkanüle mit Gewindeadapter, Ø 4,0 mm, 350 mm Arbeitslänge	MICTEC Mercedes Liposuction cannula with thread adapter, Ø 4.0 mm, 350 mm working length
	<b>46944-86-035</b>	MICTEC Hochleistungskanüle mit 9 Öffnungen, mit Gewindeadapter, Ø 3,0 mm, 350 mm Arbeitslänge	MICTEC High powered cannula with 9 openings, with thread adapter, Ø 3.0 mm, 350 mm working length
	<b>46944-87-435</b>	MICTEC Hochleistungskanüle mit 9 Öffnungen, mit Gewindeadapter, Ø 4,0 mm, 350 mm Arbeitslänge	MICTEC High powered cannula with 9 openings, with thread adapter, Ø 4.0 mm, 350 mm working length



Extra feines Präparierset für ästhetische Chirurgie z.B. Lippenvergrößerung, Ohren, Augen (Blepharoplastik), Hand- und Fußchirurgie oder als Spezialinstrumentenset für Hypospadie, Kryptorchidismus und Hernienkorrektur.

Extra delicate preparation set for cosmetic surgery, e.g. lip enhancement, ears, eyes (blepharoplasty), hand and foot surgery or special instrument set for hypospady, cryptorchidism and hernia correction.

**18964-00**

DUFNER Mikro Präparier- und Rekonstruktions Set 11 cm

bestehend aus:

**18100-13**  
DIMICRON Nadelhalter gerade 12,5 cm

**04317-50**  
STEVENS Top dur-Ipercut Präparierschere gebogen, stumpf/stumpf, 11,5 cm

**06484-61**  
Extra feine chirurgische Titan-Pinzette, 1x2 Zähne, 11 cm

**06218-50**  
Bipolar „non stick“ Pinzette, extra fein, gewinkelte Spitze 0,25 mm, 11 cm

**70350-08**  
Mini Sterilisierbox, Kunststoff, mit Silikonmattenmatte, Innenmaße 190 x 102 x 19 mm

DUFNER Micro dissection and reconstruction set 11 cm

consisting of:

**18100-13**  
DIMICRON Needle holder, straight, 12.5 cm

**04317-50**  
STEVENS Top dur-Ipercut dissecting scissors, curved, blunt/blunt, 11.5 cm

**06484-61**  
Extra fine tissue titanium forceps, 1x2 teeth, 11 cm

**06218-50**  
Bipolar „non stick“ forceps, extra fine angled tip, 0.25 mm, 11 cm

**70350-08**  
Mini Sterilization box, plastic, with silicone mat, inner dimension 190 x 102 x 19 mm



**04317-00-010**

IC Ciradur Stevensschere gebogen 11,5 cm      IC Ciradur Stevens scissors curved, 11.5 cm

**04337-00-010**

IC Ciradur Jameson Schere gebogen, 15 cm      IC Ciradur Jameson scissors curved, 15 cm

**04317-01**

Stevens IPERCUT Schere gebogen, 12,5 cm/5"      Stevens IPERCUT scissors curved, 12.5 cm/5"



**04317-50**

Stevens Top dur-Ipercut Präparier-schere gebogen, stumpf/stumpf, 11,5 cm/4½"      Stevens Top dur-Ipercut dissecting scissors, curved, blunt/blunt, 11.5 cm/4½"

**04317-51**

Stevens Top dur-IPERCUT Schere gebogen, 12,5 cm/5"      Stevens Top dur-IPERCUT scissors curved, 12.5 cm/5"

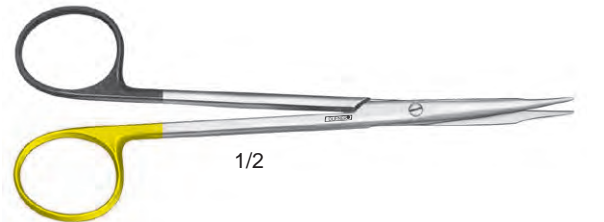

**04337-00**

Jameson IPERCUT Schere gebogen, 15 cm/6"      Jameson IPERCUT scissors curved, 15 cm/6"

**04337-50**

Jameson Top dur-IPERCUT Schere gebogen, 15 cm/6"      Jameson Top dur-IPERCUT scissors curved, 15 cm/6"

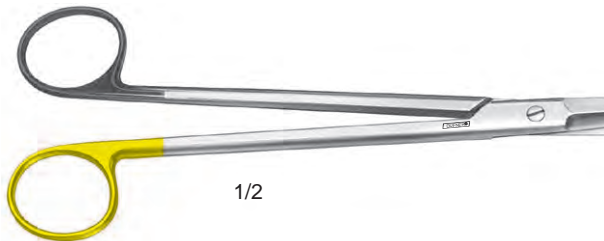

**04299-01**

Gorney IPERCUT Schere gerade, 20 cm/8"      Gorney IPERCUT scissors straight, 20 cm/8"

**04299-51**

Gorney Top dur-IPERCUT Schere gerade, 20 cm/8"      Gorney Top dur-IPERCUT scissors straight, 20 cm/8"

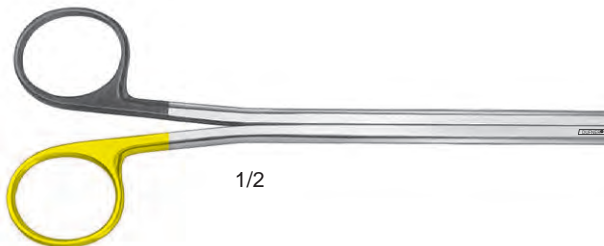

**04300-02**

Gorney Face-Lift IPERCUT Schere gebogen, 23 cm/9"      Gorney Face-Lift IPERCUT scissors curved, 23 cm/9"

**04300-52**

Gorney Face-Lift Top dur-IPER-CUT Schere gebogen, 23 cm/9"      Gorney Face-Lift Top dur-IPER-CUT scissors curved, 23 cm/9"

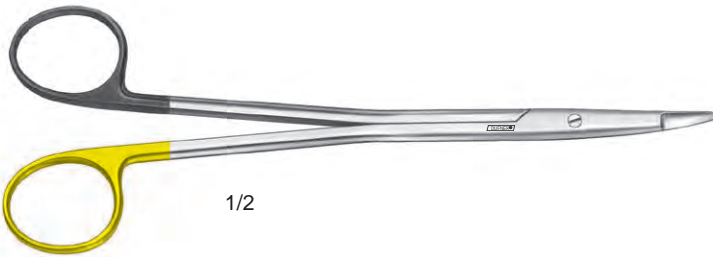

1/2

**04331-00**

Freeman IPERCUT Schere gebogen, 18 cm/7 1/4"

Freeman IPERCUT scissors curved, 18 cm/7 1/4"



1/2

**04331-50**

Freeman Top dur-IPERCUT Schere gebogen, 18 cm/7 1/4"

Freeman Top dur-IPERCUT scissors curved, 18 cm/7 1/4"

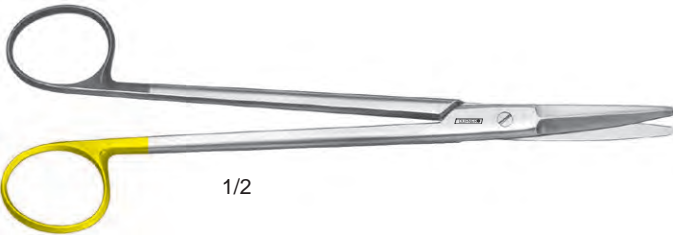

1/2

**04335-00**

Freeman Kaye IPERCUT Schere gebogen, 19 cm/7 1/2"

Freeman Kaye IPERCUT scissors curved, 19 cm/7 1/2"

**04335-50**

Freeman Kaye Top dur-IPERCUT Schere gebogen, 19 cm/7 1/2"

Freeman Kaye Top dur-IPERCUT scissors curved, 19 cm/7 1/2"



1/2

**04457-00**

Gorney (Böttcher) IPERCUT Schere gebogen, 18,5 cm/7 1/4"

Gorney (Böttcher) IPERCUT scissors curved, 18.5 cm/7 1/4"

**04457-50**

Gorney (Böttcher) Top dur-IPERCUT Schere gebogen, 18,5 cm/7 1/4"

Gorney (Böttcher) Top dur-IPERCUT scissors curved, 18.5 cm/7 1/4"



1/2

**04458-20**

IC Präparierschere, stark gerundet, 20 cm

IC Dissecting scissors, strong rounded, 20 cm



1/2

**04459-20**

IC Präparierschere, stark gerundet, Pyramidal-Form, 20 cm

IC Dissecting scissors, strong rounded, pyramidal form, 20 cm

**04963-11**

Greenberg Par Top dur Schere gebogen, 11,5 cm/4 1/2"

Greenberg Par Top dur scissors curved, 11.5 cm/4 1/2"





1/2

Weitere Nadelhalter und Scherenmodelle  
finden Sie in unserem Top dur Spezialkatalog  
Further needle holders and scissors you see  
in our Top dur speciality catalogue

**18049-01**

Heaney Top dur Nadelhalter mit  
kurzem HM Maulteil und Spiegel,  
gebogen, 20 cm/8"

Heaney Top dur Needle holder  
with short tungsten carbide jaw  
and blank part, curved, 20 cm/8"

18 cm

16 cm

15 cm

13 cm



**18100-13**

DIMICRON Nadelhalter, Maul gerade,  
13 cm

DIMICRON Needle holder, jaws straight,  
13 cm

**18100-15**

DIMICRON Nadelhalter, Maul gerade,  
15 cm

DIMICRON Needle holder, jaws straight,  
15 cm

**18100-16**

DIMICRON Nadelhalter, Maul gerade,  
16 cm

DIMICRON Needle holder, jaws straight,  
16 cm

**18100-18**

DIMICRON Nadelhalter, Maul gerade,  
18 cm

DIMICRON Needle holder, jaws straight,  
18 cm

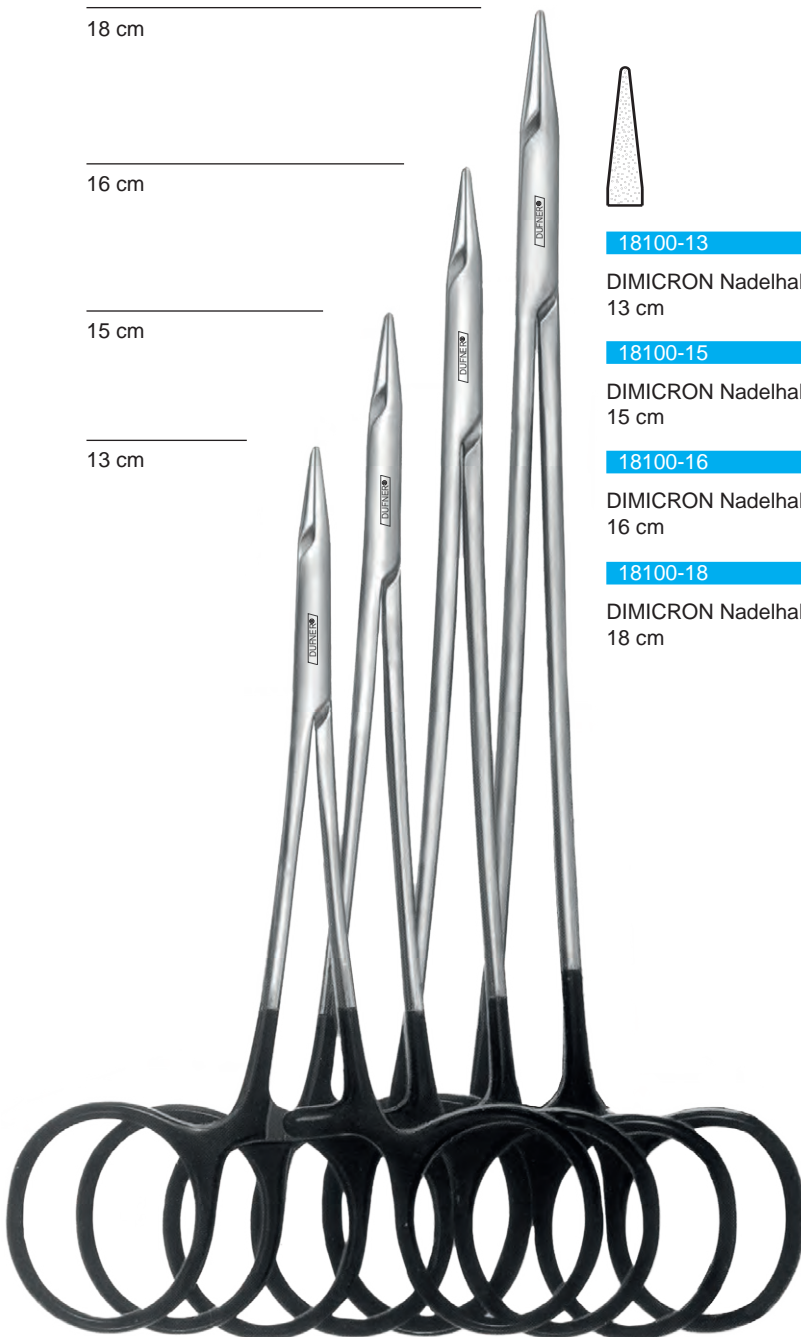

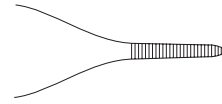

**06140-12**

Adson anatomische Pinzette, 12 cm      Adson dressing forceps, 12 cm

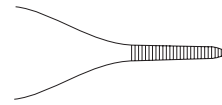
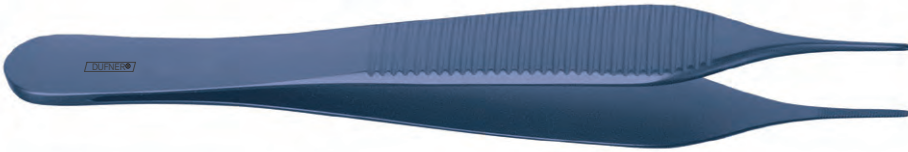

**TITANIUM**

**06140-52**

Adson anatomische Pinzette, 12 cm      Adson dressing forceps, 12 cm

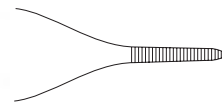

**06140-13**

DUFNER Adson anatomische Pinzette, 13 cm      DUFNER Adson dressing forceps, 13 cm

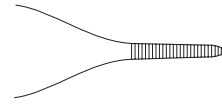

**TITANIUM**

**06140-53**

DUFNER Adson anatomische Pinzette, 13 cm      DUFNER Adson dressing forceps, 13 cm

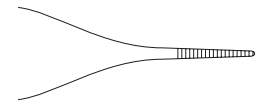

**06376-15**

Mikro Streli-Adson anatomische Pinzette, 15 cm      Micro Streli-Adson dressing forceps, 15 cm

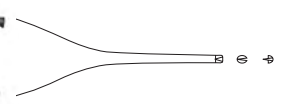

**06378-15**

Mikro Streli-Adson chirurgische Pinzette, 1x2 Zähne, 15 cm      Micro Streli-Adson tissue forceps, 1x2 teeth, 15 cm



**06298-13**

Chirurgische Pinzette fein, gerade, 1x2 Zähne, 13 cm  
Tissue forceps fine, straight, 1x2 teeth, 13 cm



**TITANIUM**

**06298-53**

Chirurgische Pinzette fein, gerade, 1x2 Zähne, 13 cm  
Tissue forceps fine, straight, 1x2 teeth, 13 cm



**06340-12**

Adson chirurgische Pinzette, 1x2 Zähne, 12 cm  
Adson tissue forceps, 1x2 teeth, 12 cm



**TITANIUM**

**06340-52**

Adson chirurgische Pinzette, 1x2 Zähne, 12 cm  
Adson tissue forceps, 1x2 teeth, 12 cm



**06340-13**

DUFNER Adson chirurgische Pinzette, 1x2 Zähne, 13 cm  
DUFNER Adson tissue forceps, 1x2 teeth, 13 cm



**TITANIUM**

**06340-53**

DUFNER Adson chirurgische Pinzette, 1x2 Zähne, 13 cm  
DUFNER Adson tissue forceps, 1x2 teeth, 13 cm

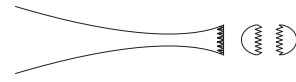

**06374-12**

Adson-Graefe, chirurgische  
Pinzette, 12 cm

Adson-Graefe, tissue  
forceps, 12 cm

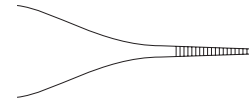

**06376-12**

Mikro Adson anatomische  
Pinzette, 12 cm

Micro Adson dressing  
forceps, 12 cm



**TITANIUM**

**06376-52**

Mikro Adson anatomische  
Pinzette, 12 cm

Micro Adson dressing  
forceps, 12 cm

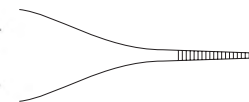

**06376-13**

DUFNER Mikro Adson anatomi-  
sche Pinzette, 13 cm

DUFNER Mikro Adson dres-  
sing forceps, 13 cm



**TITANIUM**

**06376-53**

DUFNER Mikro Adson anatomi-  
sche Pinzette, 13 cm

DUFNER Mikro Adson dres-  
sing forceps, 13 cm

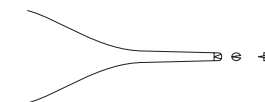

**06378-12**

Mikro Adson chirurgische  
Pinzette, 1x2 Zähne, 12 cm

Micro Adson tissue forceps,  
1x2 teeth, 12 cm

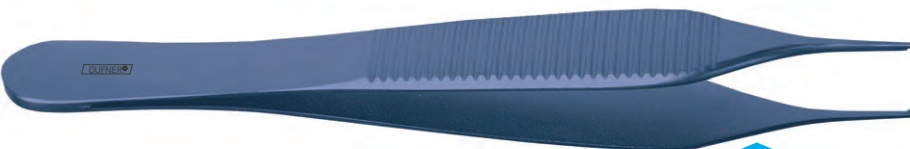

**TITANIUM**

**06378-52**

Mikro Adson chirurgische  
Pinzette, 1x2 Zähne, 12 cm

Micro Adson tissue forceps,  
1x2 teeth, 12 cm



**06378-13**

DUFNER Mikro Adson chirurgische Pinzette, 1 x 2 Zähne, 13 cm

DUFNER Mikro Adson tissue forceps, 1 x 2 teeth, 13 cm



**TITANIUM**

**06378-53**

DUFNER Mikro Adson chirurgische Pinzette, 1 x 2 Zähne, 13 cm

DUFNER Mikro Adson tissue forceps, 1 x 2 teeth, 13 cm



**06484-21**

Feine chirurgische Pinzette, 1 x 2 Zähne, 11 cm

Fine tissue forceps, 1 x 2 teeth, 11 cm



**TITANIUM**

**06484-61**

Feine chirurgische Pinzette, 1 x 2 Zähne, 11 cm

Fine tissue forceps, 1 x 2 teeth, 11 cm



**06570-13**

Feine Pinzette gerade, 13 cm

Fine forceps straight, 13 cm



**06570-18**

Feine Pinzette gerade, 18 cm

Fine forceps straight, 18 cm



**06570-20**

Feine Pinzette gerade, 20 cm

Fine forceps straight, 20 cm

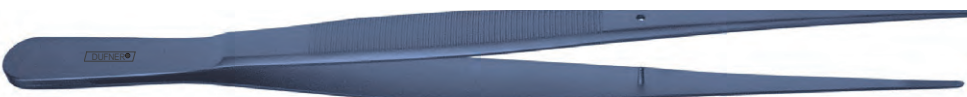

**06570-53**

Feine Pinzette gerade, 13 cm

Fine forceps straight, 13 cm

**TITANIUM**



**06570-58**

Feine Pinzette gerade, 18 cm

Fine forceps straight, 18 cm

**TITANIUM**



**06570-60**

Feine Pinzette gerade, 20 cm

Fine forceps straight, 20 cm

**TITANIUM**





**06158-18**

Gerald anatomische Pinzette  
gerade, 17,5 cm

Gerald dressing forceps  
straight, 17.5 cm



**06358-17**

Gerald chirurgische Pinzette  
gerade, 1x2 Zähne, 17,5 cm

Gerald tissue forceps  
straight, 1x2 teeth, 17.5 cm



**06158-58**

Gerald anatomische Pinzette  
gerade, 17,5 cm

Gerald dressing forceps  
straight, 17.5 cm



**06358-57**

Gerald chirurgische Pinzette  
gerade, 1x2 Zähne, 17,5 cm

Gerald tissue forceps  
straight, 1x2 teeth, 17.5 cm



**22360-16**

DeBakey atrauma Pinzette  
gerade, 2,0 mm breit, 16 cm

DeBakey atrauma forceps  
straight, 2.0 mm wide, 16 cm



**22360-20**

DeBakey atrauma Pinzette  
gerade, 2,0 mm breit, 20 cm

DeBakey atrauma forceps  
straight, 2.0 mm wide, 20 cm



**22360-55**

DeBakey atrauma Pinzette  
gerade, 2,0 mm breit, 15 cm

DeBakey atrauma forceps  
straight, 2.0 mm wide, 15 cm

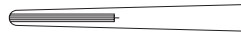

**22360-60**

DeBakey atrauma Pinzette  
gerade, 2,0 mm breit, 20 cm

DeBakey atrauma forceps  
straight, 2.0 mm wide, 20 cm





**06802-11**

Juwelier Pinzette, gerade,  
11 cm

Jeweler forceps, straight,  
11 cm

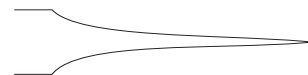

TITANIUM

**06802-51**

Juwelier Pinzette, gerade,  
11 cm

Jeweler forceps, straight,  
11 cm



**06803-11**

Juwelier Pinzette, abgewin-  
kelt, 11 cm

Jeweler forceps, curved,  
11 cm

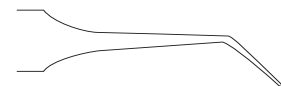

TITANIUM

**06803-51**

Juwelier Pinzette, abgewin-  
kelt, 11 cm

Jeweler forceps, curved,  
11 cm

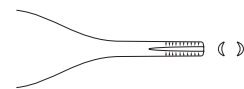

**06372-12**

Adson-Brown chirurgische  
Pinzette, 7 x 7 Zähne, 12 cm

Adson-Brown Tissue forceps,  
7 x 7 teeth, 12 cm

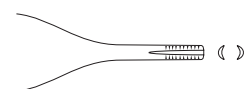

TITANIUM

**06372-52**

Adson-Brown chirurgische  
Pinzette, 7 x 7 Zähne, 12 cm

Adson-Brown Tissue forceps,  
7 x 7 teeth, 12 cm



**08262-14**

Martel Kopfhautklemme, 14 cm

Martel Facelift forceps, 14 cm

**08257-15**

Marten Hautlappen Klemme, ohne Sperre, 15 cm

Marten Flap forceps, without ratchet, 15 cm

**08257-65**

Marten Hautlappen Klemme, mit Sperre, 15 cm

Marten Flap forceps, with ratchet, 15 cm

**08258-15**

Pitanguy Hautlappen Markierungsklemme, ohne Sperre, 16 cm

Pitanguy Skin marking forceps, without ratchet, 16 cm

**08259-16**

D'Assumpcao Hautlappen Markierungsklemme, 3 x 2 Zähne, ohne Sperre, 16 cm

D'Assumpcao Skin marking forceps, 3 x 2 teeth, without ratchet, 16 cm

**08259-24**

D'Assumpcao Hautlappen Markierungsklemme, 3 x 2 Zähne, ohne Sperre, 26 cm

D'Assumpcao Skin marking forceps, 3 x 2 teeth, without ratchet, 26 cm

**08259-66**

D'Assumpcao Hautlappen Markierungsklemme, 3 x 2 Zähne, mit Sperre, 16 cm

D'Assumpcao Skin marking forceps, 3 x 2 teeth, with ratchet, 16 cm

**08259-74**

D'Assumpcao Hautlappen Markierungsklemme, 3 x 2 Zähne, mit Sperre, 26 cm

D'Assumpcao Skin marking forceps, 3 x 2 teeth, with ratchet, 26 cm

**08259-17**

D'Assumpcao Hautlappen Markierungsklemme, 3 x 3 Zähne, ohne Sperre, 16 cm

D'Assumpcao Skin marking forceps, 3 x 3 teeth, without ratchet, 16 cm

**08259-26**

D'Assumpcao Hautlappen Markierungsklemme, 3 x 3 Zähne, ohne Sperre, 26 cm

D'Assumpcao Skin marking forceps, 3 x 3 teeth, without ratchet, 26 cm

**08259-67**

D'Assumpcao Hautlappen Markierungsklemme, 3 x 3 Zähne, mit Sperre, 16 cm

D'Assumpcao Skin marking forceps, 3 x 3 teeth, with ratchet, 16 cm

**08259-76**

D'Assumpcao Hautlappen Markierungsklemme, 3 x 3 Zähne, mit Sperre, 26 cm

D'Assumpcao Skin marking forceps, 3 x 3 teeth, with ratchet, 26 cm





**08258-26**

Pitanguy Hautlappen Markierungsklemme,  
ohne Sperre, 25,5 cm

Pitanguy Skin marking forceps, without  
ratchet, 25.5 cm



**08259-18**

D'Assumpcao Demarkator für  
Bauchklappe, ohne Sperre, 30 cm

D'Assumpcao Abdominal flap demarcator,  
without ratchet, 30 cm



**08259-19**

Lockwood Demarkator für Bauchklappe,  
ohne Sperre, 32,5 cm

Lockwood Abdominal flap demarcator,  
without ratchet, 32.5 cm



**12114-04**

Wundhaken 7-zinkig, Blattbreite 70 mm, Griffhaken nach hinten gebogen, 18 cm  
Retractor 7 prongs, blade width 70 mm, grip hook reverse, 18 cm

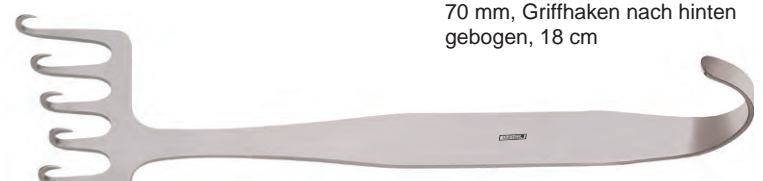

**12114-06**

Wundhaken, 7-zinkig, Blattbreite 70 mm, Griffhaken nach vorne gebogen, 18 cm  
Retractor, 7 prongs, blade width 70 mm, grip hook front, 18 cm



**12114-05**

Wundhaken, 6-zinkig, Blattbreite 150 mm, 23 cm  
Retractor, 6 prongs, blade width 150 mm, 23 cm



**12114-10**

Freeman Wundhaken, 4-zinkig, Blattbreite 22 mm, 10 cm  
Freeman Retractor, 4 prongs, blade width 22 mm, 10 cm

**12114-12**

Freeman Wundhaken, 4-zinkig, Blattbreite 38 mm, 10 cm  
Freeman Retractor, 4 prongs, blade width 38 mm, 10 cm



**12114-13**

Freeman Wundhaken, 4-zinkig, 2 abgesetzte Zinken, Blattbreite 22 mm, 10 cm  
Freeman Retractor, 4 prongs, 2 recessed prongs, blade width 22 mm, 10 cm



**12114-14**

Maxwell Wundhaken, Blattbreite 22 mm, 10 cm  
Maxwell Retractor, blade width 22 mm, 10 cm

**12114-16**

Maxwell Wundhaken, Blattbreite 38 mm, 10 cm  
Maxwell Retractor, blade width 38 mm, 10 cm



**12114-30**

Freeman Wundhaken 4-zinkig spitz, Blattbreite 38 mm, 18 cm

Freeman retractor 4 prongs sharp, blade width 38 mm, 18 cm



**12114-34**

Van Sickle Wundhaken, 4-zinkig stumpf, 2 abgesetzte Zinken, Blattbreite 19 mm, 18 cm

Van Sickle Retractor, 4 prongs blunt, 2 recessed prongs, blade width 19 mm, 18 cm



**12114-36**

Van Sickle Wundhaken, 4-zinkig spitz, 2 abgesetzte Zinken, Blattbreite 19 mm, 18 cm

Van Sickle Retractor, 4 prongs sharp, 2 recessed prongs, blade width 19 mm, 18 cm



**12114-38**

Freeman Wundhaken, 4-zinkig spitz, Blattbreite 22 mm, 18 cm

Freeman Retractor, 4 prongs sharp, blade width 22 mm, 18 cm



**12114-40**

Freeman Wundhaken, 4-zinkig spitz, Blattbreite 38 mm, 18 cm

Freeman Retractor, 4 prongs sharp, blade width 38 mm, 18 cm



**12114-42**

Freeman Wundhaken, 4-zinkig spitz, 2 abgesetzte Zinken, Blattbreite 22 mm, 18 cm

Freeman Retractor, 4 prongs sharp, 2 recessed prongs, blade width 22 mm, 18 cm



**12114-44**

Freeman Wundhaken, 4-zinkig spitz, 2 abgesetzte Zinken, Blattbreite 38 mm, 18 cm

Freeman Retractor, 4 prongs sharp, 2 recessed prongs, blade width 38 mm, 18 cm



**12114-70**

Yoncoskie Bauchstraffung-  
Wundhaken, 6-zinkig, Blattbreite  
150 mm, 19 cm

Yoncoskie Abdominoplasty  
retractor, 6 prongs, blade width  
150 mm, 19 cm

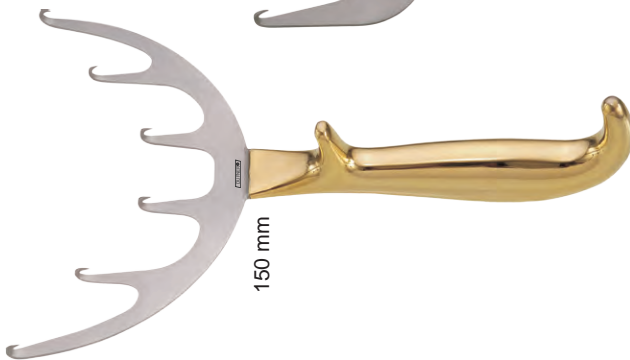

**12114-72**

Yoncoskie Wundhaken, 6-zinkig,  
Blattbreite 150 mm, 21 cm

Yoncoskie retractor, 6 prongs,  
blade width 150 mm, 21 cm



**12114-26**

Gorney Wundhaken mit Feder,  
Blattbreite 38 mm, 7,5 cm

Gorney Retractor with spring,  
blade width 38 mm, 7.5 cm

**12114-28**

Gorney Wundhaken mit Feder,  
Blattbreite 38 mm, 10,8 cm

Gorney Retractor with spring,  
blade width 38 mm, 10.8 cm

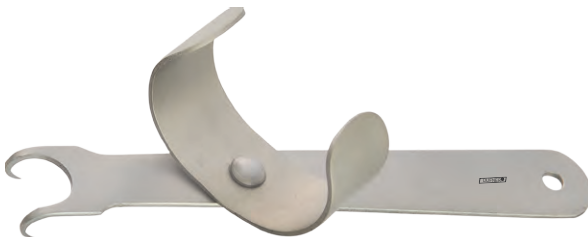

**12114-50**

Martinez Kilner Wundhaken,  
2-zinkig, 10 mm breit, 8 cm

Martinez Kilner Retractor,  
2 prongs, 10 mm width, 8 cm



**12114-52**

Martinez Kilner Wundhaken,  
2-zinkig, 7,5 mm breit, 11,5 cm

Martinez Kilner Retractor,  
2 prongs, 7.5 mm width, 11.5 cm



**44672-10**

Converse Wundhaken, doppel-  
endig, 10/14 mm, stumpf, 12 cm

Converse Retractor, double  
ended, 10/14 mm, blunt, 12 cm

**44672-12**

Converse Wundhaken, doppel-  
endig, 10/14 mm, scharf, 12 cm

Converse Retractor, double  
ended, 10/14 mm, sharp, 12 cm

**Wundhaken  
Retractors**



**12114-20**

Freeman Mini-Wundhaken, 4-zinkig spitz,  
2 abgesetzte Zinken, Blattbreite 20 mm, 5 cm

Freeman Mini retractor, 4 prongs sharp,  
2 recessed prongs, blade width 20 mm, 5 cm

**12114-21**

Freeman Mini-Wundhaken, 4-zinkig spitz,  
2 abgesetzte Zinken, Blattbreite 38 mm, 5 cm

Freeman Mini retractor, 4 prongs sharp,  
2 recessed prongs, blade width 38 mm, 5 cm



**12114-22**

Freeman Mini-Wundhaken, 4-zinkig spitz,  
Blattbreite 20 mm, 5 cm

Freeman Mini retractor, 4 prongs sharp,  
blade width 20 mm, 5 cm

**12114-23**

Freeman Mini-Wundhaken, 4-zinkig spitz,  
Blattbreite 38 mm, 5 cm

Freeman Mini retractor, 4 prongs sharp,  
blade width 38 mm, 5 cm



**12114-54**

Millard (Cottle) Fingerring Haken, mit  
Daumenhut einstellbar, Breite 8 mm,  
Tiefe 5 mm, 5,5 cm

Millard (Cottle) Fingerring hook, with  
adjustable thimble, width 8 mm,  
depth 5 mm, 5,5 cm

**12114-56**

Millard (Cottle) Fingerring Haken, mit  
Daumenhut einstellbar, Breite 12 mm,  
Tiefe 5 mm, 5,5 cm

Millard (Cottle) Fingerring hook, with  
adjustable thimble, width 12 mm,  
depth 5 mm, 5,5 cm



**12114-58**

Millard Haken, 1-zinkig, für die rechte Hand,  
Blattbreite 18 mm

Millard Hook, 1 prong, for the right hand,  
blade width 18 mm

**12114-60**

Millard Haken, 1-zinkig, für die linke Hand,  
Blattbreite 18 mm

Millard Hook, 1 prong, for the left hand,  
blade width 18 mm

**12114-62**

Millard Haken, 2-zinkig, für die rechte  
Hand, Blattbreite 18 mm

Millard Hook, 2 prongs, for the right hand,  
blade width 18 mm

**12114-64**

Millard Haken, 2-zinkig, für die linke Hand,  
Blattbreite 18 mm

Millard Hook, 2 prongs, for the left hand,  
blade width 18 mm



**Häkchen  
Hooks**



**34177-18**

Gillies Hauthäkchen Fig.0, 18 cm

Gillies Skin hooklet fig.0, 18 cm



**34179-18**

Gillies Hauthäkchen Fig.1, 18 cm

Gillies Skin hooklet fig.1, 18 cm



**34181-18**

Gillies Hauthäkchen Fig.2, 18 cm

Gillies Skin hooklet fig.2, 18 cm



**38688-13**

Rollet Hauthäkchen, 4-zinkig, scharf, 13 cm

Rollet Skin hooklet, 4 prongs, sharp, 13 cm



**44656-15**

Joseph Hauthäkchen, 1-zinkig, scharf, 16 cm

Joseph Skin hooklet, 1 prong, sharp, 16 cm



**44676-02**

Joseph Hauthäkchen, 2-zinkig, scharf,  
2 mm, 16 cm

Joseph Skin hooklet, 2 prongs, sharp,  
2 mm, 16 cm

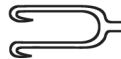

**44676-05**

Joseph Hauthäkchen, 2-zinkig, scharf,  
5 mm, 16 cm

Joseph Skin hooklet, 2 prongs, sharp,  
5 mm, 16 cm



**44676-07**

Joseph Hauthäkchen, 2-zinkig, scharf,  
7 mm, 16 cm

Joseph Skin hooklet, 2 prongs, sharp,  
7 mm, 16 cm



**44676-10**

Joseph Hauthäkchen, 2-zinkig, scharf,  
10 mm, 16 cm

Joseph Skin hooklet, 2 prongs, sharp,  
10 mm, 16 cm

**Wundhaken  
Retractors**



**34175-02**

Barsky Wundhaken, 1-zinkig, 3 mm, 15 cm

Barsky Retractor, 1 prongs, 3 mm, 15 cm



**34175-04**

Barsky Wundhaken, 2-zinkig, 3 mm, 15 cm

Barsky Retractor, 2 prongs, 3 mm, 15 cm



**46218-00**

Logan Lippenbogen mit Zähne, 28 mm

Logan Lip traction bow retractor, with teeth, 28 mm

**46218-02**

Logan Lippenbogen mit Zähne, 32 mm

Logan Lip traction bow retractor, with teeth, 32 mm

**46218-04**

Logan Lippenbogen mit Zähne, 35 mm

Logan Lip traction bow retractor, with teeth, 35 mm

**46218-10**

Logan Lippenbogen ohne Zähne, 28 mm

Logan Lip traction bow retractor, without teeth, 28 mm

**46218-12**

Logan Lippenbogen ohne Zähne, 32 mm

Logan Lip traction bow retractor, without teeth, 32 mm

**46218-14**

Logan Lippenbogen ohne Zähne, 35 mm

Logan Lip traction bow retractor, without teeth, 35 mm



**12114-00**

Anderson Bärenkrallen, 3-zinkig, scharf, Gesamtlänge 7 cm

Anderson Bear claw, 3 prongs, sharp, total length 7 cm

**12114-02**

Anderson Bärenkrallen, 3-zinkig, scharf, Gesamtlänge 12 cm

Anderson Bear claw, 3 prongs, sharp, total length 12 cm



**12114-01**

Anderson Bärenkrallen, 5-zinkig, scharf, Gesamtlänge 7 cm

Anderson Bear claw, 5 prongs, sharp, total length 7 cm

**12114-03**

Anderson Bärenkrallen, 5-zinkig, scharf, Gesamtlänge 12 cm

Anderson Bear claw, 5 prongs, sharp, total length 12 cm



länge/ length	Wundhaken/ Retractor	blatt gerade/ blade straight	blatt gebogen/ blade curved
26 cm	<b>46935-65</b>	38 mm x 70 mm	22 mm x 55 mm
23 cm	<b>46935-66</b>	34 mm x 70 mm	20 mm x 60 mm
23 cm	<b>46935-67</b>	34 mm x 100 mm	20 mm x 60 mm
24 cm	<b>46935-68</b>	38 mm x 70 mm	22 mm x 55 mm
31,5 cm	<b>46935-69</b>	38 mm x 70 mm	22 mm x 55 mm



**12563-14**

Deaver Wundhaken 25 mm breit, mit  
Fiberglaslichtträger, 30 cm

Deaver Retractor, 25 mm wide, with fiber-  
glass light carrier, 30 cm



**12565-27**

Deaver Wundhaken mit Kehlegriff,  
25 mm, mit Fiberglaslichtträger, 31 cm

Deaver Retractor, with grip handle,  
25 mm, with fiberglass light carrier, 31 cm

**12565-25**

170 mm

Deaver Wundhaken mit Kehlegriff,  
25 mm, 31 cm

Deaver Retractor, with grip handle,  
25 mm, 31 cm



**12553-10**

Breisky-Harrington Wundhaken, 35 x 25 mm,  
Arbeitslänge 170 mm

Breisky-Harrington Retractor, 35 x 25 mm,  
working length 170 mm

**12553-12**

Breisky-Harrington Wundhaken, mit  
Fiberglaslichtträger, 35 x 25 mm,  
Arbeitslänge 170 mm

Breisky-Harrington Retractor, with fiber-  
glass light carrier, 35 x 25 mm, working  
length 170 mm





**46934-80**

Saldanha-Solz Brustretraktor, Blatt  
155 x 60 mm, 23,5 cm

Saldanha-Solz Breast retractor, blade  
155 x 60 mm, 23.5 cm

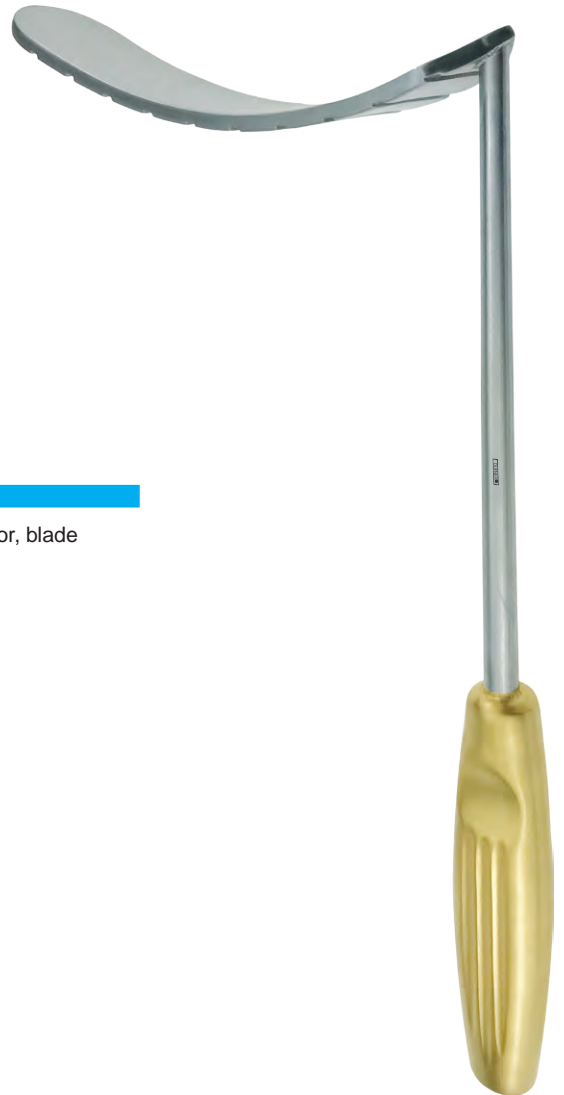

**46934-40**

Brustretraktor, Blatt 125 x 30 mm, 27 cm

Breast retractor, blade 125 x 30 mm, 27 cm

**46934-42**

Brustretraktor, Blatt 140 x 30 mm, 27 cm

Breast retractor, blade 140 x 30 mm, 27 cm

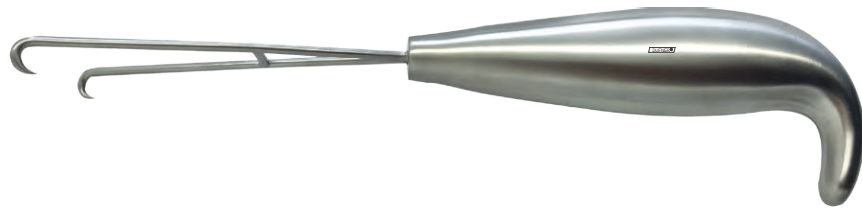

**12114-76**

Berens Hautlappen Wundhaken, 2-zinkig,  
scharf, 20 cm

Berens Skin flap retractor, 2 prongs, sharp,  
20 cm

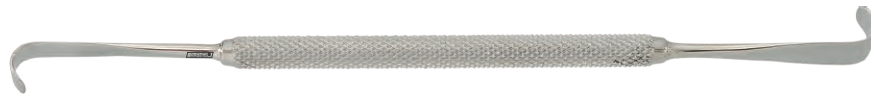

**12114-74**

Kasdan Doppel-Wundhaken, 19 x 9,5/  
13 x 6,5 mm, 16 cm

Kasdan Double retractor, 19 x 9.5/  
13 x 6.5 mm, 16 cm



**44676-12**

Cronin Lippen- und Nasenhaken, 2-zinkig,  
stumpf, 15,5 cm

Cronin Lips and nose hook, 2 prongs, blunt,  
15.5 cm



**44676-14**

Parkes Nasenwundhaken, 8 mm breit,  
15 cm

Parkes Nasal retractor, 8 mm wide,  
15 cm

**Wundhaken  
Retractors**



**44669-30**

Maliniac Wundhaken, Blatt 9 x 45 mm,  
10 cm

Maliniac Retractor, blade 9 x 45 mm, 10 cm

**44669-32**

Maliniac Wundhaken, Blatt 9 x 45 mm,  
mit Fiberglaslichtträger, 10 cm

Maliniac Retractor, blade 9 x 45 mm,  
with fiberglass light carrier, 10 cm



**44669-40**

Converse Wundhaken, Blatt 10 x 20 mm,  
9 cm

Converse Retractor, blade 10 x 20 mm,  
9 cm

**44669-42**

Converse Wundhaken, Blatt 12 x 30 mm,  
9 cm

Converse Retractor, blade 12 x 30 mm,  
9 cm

**44669-44**

Converse Wundhaken, Blatt 12 x 40 mm,  
9 cm

Converse Retractor, blade 12 x 40 mm,  
9 cm

**44669-46**

Converse Wundhaken, Blatt 12 x 50 mm,  
9 cm

Converse Retractor, blade 12 x 50 mm,  
9 cm

**44669-41**

Converse Wundhaken, mit Fiberglaslicht-  
träger, Blatt 10 x 20 mm, 9 cm

Converse Retractor, with fiberglass light  
carrier, blade 10 x 20 mm, 9 cm

**44669-43**

Converse Wundhaken, mit Fiberglaslicht-  
träger, Blatt 12 x 30 mm, 9 cm

Converse Retractor, with fiberglass light  
carrier, blade 12 x 30 mm, 9 cm

**44669-45**

Converse Wundhaken, mit Fiberglaslicht-  
träger, Blatt 12 x 40 mm, 9 cm

Converse Retractor, with fiberglass light  
carrier, blade 12 x 40 mm, 9 cm

**44669-47**

Converse Wundhaken, mit Fiberglaslicht-  
träger, Blatt 12 x 50 mm, 9 cm

Converse Retractor, with fiberglass light  
carrier, blade 12 x 50 mm, 9 cm



**44669-16**

Aufricht Nasenhaken, Blatt 7 mm breit,  
16 cm

Aufricht Nose hook, blade 7 mm wide,  
16 cm

**44669-19**

Aufricht Nasenhaken, Blatt 10 mm breit,  
19 cm

Aufricht Nose hook, blade 10 mm wide,  
19 cm

**44669-17**

Aufricht Nasenhaken, mit Fiberglaslicht-  
träger, Blatt 7 mm breit, 16 cm

Aufricht Nose hook, with fiberglass light  
carrier, blade 7 mm wide, 16 cm

**44669-20**

Aufricht Nasenhaken, mit Fiberglaslicht-  
träger, Blatt 10 mm breit, 19 cm

Aufricht Nose hook, with fiberglass light  
carrier, blade 10 mm wide, 19 cm



**44671-15**

Aufricht Nasenhaken, mit Fiberglaslicht-  
träger, 10 mm breit, 16 cm

Aufricht Nose hook, fiberglass light carrier,  
10 mm wide, 16 cm

**44669-60**

Freeman Wundhaken, Blatt 12 mm,  
20 cm

Freeman Retractor, blade 12 mm, 20 cm

**44669-62**

Freeman Wundhaken, Blatt 25 mm,  
20 cm

Freeman Retractor, blade 25 mm, 20 cm

**44669-61**

Freeman Wundhaken, mit Fiberglaslicht-  
träger, Blatt 12 mm, 20 cm

Freeman Retractor, with fiberglass light  
carrier, blade 12 mm, 20 cm

**44669-63**

Freeman Wundhaken, mit Fiberglaslicht-  
träger, Blatt 25 mm, 20 cm

Freeman Retractor, with fiberglass light  
carrier, blade 25 mm, 20 cm



**Markierer  
Marker**



**46931-25**

MICTEC Areola Markierungsring, scharf/stumpf, Ø 25 mm

MICTEC Areola marking ring, sharp/blunt, Ø 25 mm

**46931-30**

Ø 30 mm

Ø 30 mm

**46931-34**

Ø 34 mm

Ø 34 mm

**46931-36**

Ø 36 mm

Ø 36 mm

**46931-38**

Ø 38 mm

Ø 38 mm

**46931-40**

Ø 40 mm

Ø 40 mm

**46931-42**

Ø 42 mm

Ø 42 mm

**46931-44**

Ø 44 mm

Ø 44 mm

**46931-45**

Ø 45 mm

Ø 45 mm

**46931-50**

Ø 50 mm

Ø 50 mm



**46931-89**

MICTEC Areola Markierungsring, zweifach, Ø 34/36 mm

MICTEC Areola marking ring, double, Ø 34/36 mm

**46931-90**

Ø 38/42 mm

Ø 38/42 mm

**46931-91**

Ø 42/45 mm

Ø 42/45 mm

**46931-92**

Ø 45/50 mm

Ø 45/50 mm



**46931-95**

MICTEC Areola 4-fach Markierungsring 40 mm, 44 mm, 48 mm und 52 mm, für die Markierung mit Tinte

MICTEC Areola four ring marker 40 mm, 44 mm, 48 mm und 52 mm, for marking with ink

**Markierer  
Marker**



**46931-51**

MICTEC Areola Markierungsring Freeman,  
zweifach, stumpf, Ø 34/36 mm

MICTEC Areola marking ring Freeman,  
double, blunt, Ø 34/36 mm

**46931-52**

Ø 38/42 mm

Ø 38/42 mm

**46931-53**

Ø 45/50 mm

Ø 45/50 mm



**46931-56**

MICTEC Areola Markierungsring Freeman,  
scharf/stumpf, Ø 34 mm

MICTEC Areola marking ring Freeman,  
sharp/blunt, Ø 34 mm

**46931-57**

Ø 36 mm

Ø 36 mm

**46931-58**

Ø 38 mm

Ø 38 mm

**46931-59**

Ø 42 mm

Ø 42 mm

**46931-60**

Ø 45 mm

Ø 45 mm

**46931-61**

Ø 50 mm

Ø 50 mm



**46931-65**

MICTEC Areola Markierungsring Freeman,  
stumpf, Ø 32 mm

MICTEC Areola marking ring Freeman,  
blunt, Ø 32 mm

**46931-66**

Ø 37 mm

Ø 37 mm

**46931-67**

Ø 43 mm

Ø 43 mm

**46931-68**

Ø 45 mm

Ø 45 mm

**46931-69**

Ø 50 mm

Ø 50 mm



**46931-70**

MICTEC Areola Markierungsring Freeman,  
scharf, Ø 32 mm

MICTEC Areola marking ring Freeman,  
sharp, Ø 32 mm

**46931-71**

Ø 37 mm

Ø 37 mm

**46931-72**

Ø 43 mm

Ø 43 mm

**46931-74**

Ø 50 mm

Ø 50 mm

**Markierer  
Marker**



**46931-80**

MICTEC Areola Markierungsring,  
scharf/stumpf, Ø 34 mm

MICTEC Areola marking ring, sharp/blunt,  
Ø 34 mm

**46931-81**

Ø 36 mm

Ø 36 mm

**46931-82**

Ø 40 mm

Ø 40 mm

**46931-83**

Ø 42 mm

Ø 42 mm

**46931-84**

Ø 45 mm

Ø 45 mm



**46931-96**

MICTEC Areola Markierungsring Steg-  
mann, scharf/stumpf, Ø 33 mm

MICTEC Areola marking ring Stegmann,  
sharp/blunt, Ø 33 mm

**46931-97**

Ø 38 mm

Ø 38 mm

**46931-98**

Ø 42 mm

Ø 42 mm

**46931-99**

Ø 48 mm

Ø 48 mm

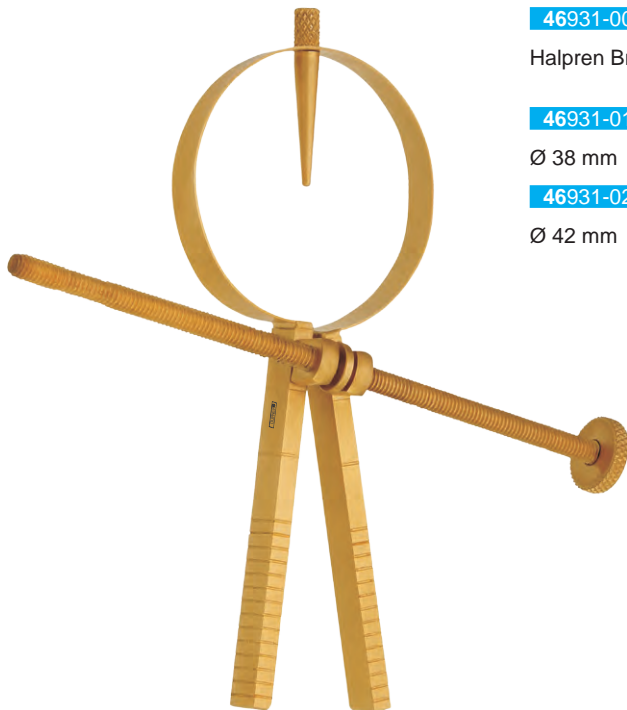

**46931-00**

Halpren Brust-Markierer, Ø 34 mm

Halpren Breast marker, Ø 34 mm

**46931-01**

Ø 38 mm

Ø 38 mm

**46931-02**

Ø 42 mm

Ø 42 mm

**Markierer  
Marker**

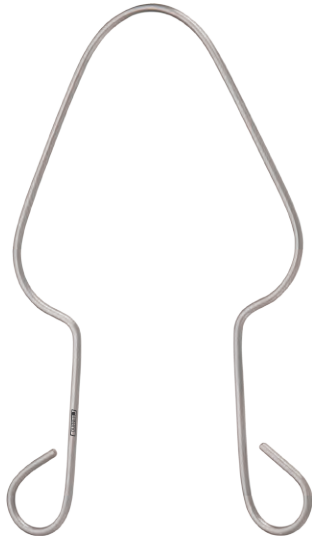

**46931-06**

Ackermann Areola Markierer klein,  
Umfanglänge 14 cm, Gesamtlänge 10 cm

Ackermann Areola Markers, small,  
circumference 14 cm, total length 10 cm

**46931-07**

Ackermann Areola Markierer groß,  
Umfanglänge 16 cm, Gesamtlänge 10 cm

Ackermann Areola Markers, large,  
circumference 16 cm, total length 10 cm



**46931-10**

McKissock Schlüsselloch-Markierer,  
Ø 38 mm, 14 cm

McKissock Keyhole marker, Ø 38 mm,  
14 cm

**46931-11**

Ø 40 mm

Ø 40 mm

**46931-12**

Ø 42 mm

Ø 42 mm

**46931-13**

Ø 45 mm

Ø 45 mm

**46931-14**

Ø 50 mm

Ø 50 mm





**46931-05**

McKissock Brust Zirkel, 30 cm

McKissock Chest Circle, 30 cm

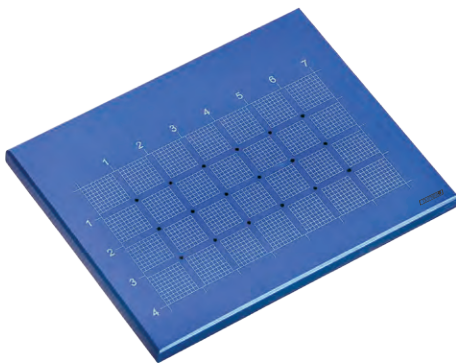

**44622-04**

Sheen Knorpelgitter, graduiert 70 x 40 mm

Sheen Cartilage grid, 70 x 40 mm



**Unser MICTEC Retraktorsystem bietet Ihnen eine Reihe von Vorteilen:**

- große Palette verschiedener Retraktorgrößen
- einen ergonomischen, stabilen Griff für optimal kontrollierte Handhabung
- gezahntes Blatt gegen abgleiten von Gewebe
- Rauchabsaugung durch den Absaugkanal für bessere Sicht
- Fiberoptische Ausleuchtung für bessere Übersicht

**Our MICTEC retractor system offers you several advantages:**

- a wide range of different blade sizes
- a comfortable, stable grip for optimized, controlled action handling
- blades are toothed to avoid tissue slippage
- suction channel removing smoke and enabling clear image
- fiber optic illumination for bright overview

**46933-00**

MICTEC Mammaplastic Retraktor mit Absaugkanal und Kaltlichtbeleuchtung, gerade, gezahnt, 90 x 24 mm

MICTEC Mammaplastic retractor with suction channel and coldlight illumination, straight, toothed, 90 x 24 mm

**46933-02**

90 x 30 mm

90 x 30 mm

**46933-04**

115 x 24 mm

115 x 24 mm

**46933-06**

150 x 36 mm

150 x 36 mm

**46933-08**

190 x 30 mm

190 x 30 mm



**46934-00**

MICTEC Mammaplastic Retraktor mit Absaugkanal und Kaltlichtbeleuchtung, rund, glatt, 80 x 16 mm

MICTEC Mammaplastic retractor with suction channel and coldlight illumination, round, smooth, 80 x 16 mm,

**46934-01**

100 x 24 mm

100 x 24 mm

**46934-02**

120 x 25 mm

120 x 25 mm

**46934-03**

120 x 30 mm

120 x 30 mm

**46934-04**

150 x 25 mm

150 x 25 mm

**46934-05**

150 x 30 mm

150 x 30 mm

**46934-06**

170 x 40 mm

170 x 40 mm

**Andere Retraktoren, auch ohne Absaugung und Lichtleiter auf Anfrage**

**Other retractors, without suction and illumination available on request**



**46935-40**

Silverstein Dissektor, leicht gebogen,  
35,5 cm

Silverstein Dissector, light curved, 35.5 cm



**46935-42**

Jacobs Weichteil Dissektor, gebogen,  
33 cm

Jacobs Soft tissue dissector, curved, 33 cm



**46935-44**

Lockwood Dissektor, gerade, Arbeitslänge  
38 cm

Lockwood Dissector, straight, working  
length 38 cm



**46935-46**

Sculpo Dissektor, gebogen, Blattbreite  
15 mm, Schaft isoliert, Arbeitslänge 32 cm

Sculpo Dissector curved, blade width 15 mm,  
shaft insulated, working length 32 cm



**46935-50**

Tebbetts Dissektor, vorne gebogen

Tebbetts Dissector, front curved

Länge/ length	starr/ rigid	biegsam/ malleable	starr Schaft isoliert/ rigid shaft insulated
33 cm	<b>46935-50</b>	<b>46935-50-010</b>	<b>46935-50-020</b>
42 cm	<b>46935-50-100</b>	<b>46935-50-110</b>	<b>46935-50-120</b>



**46935-55**

Tebbetts Dissektor, Blatt spatelförmig

Tebbetts Dissector, blades spatula shaped

Länge/ length	starr/ rigid	biegsam/ malleable	starr Schaft isoliert/ rigid shaft insulated
33 cm	<b>46935-55</b>	<b>46935-55-010</b>	<b>46935-55-020</b>
42 cm	<b>46935-55-100</b>	<b>46935-55-110</b>	<b>46935-55-120</b>



**46935-57**

Tebbetts Dissektor, Blatt oval-spatelförmig

Tebbetts Dissector, blades oval spatulated

Länge/ length	starr/ rigid	biegsam/ malleable	starr isoliert/ rigid insulated
33 cm	<b>46935-57</b>		
42 cm	<b>46935-58</b>		



**46935-59**

Reynolds Dissektor, Blatt oval-gefenestert

Reynolds Dissector, blades oval fenestrated

Länge/ length	starr/ rigid	biegsam/ malleable	starr isoliert/ rigid insulated
40 cm	<b>46935-59</b>		

**Brustspatel  
Breast Spatula**



**46935-60**

Tebbetts Brustspatel, Blattbreite 25 mm,  
31,5 cm

Tebbetts Breast spatula, blade width  
25 mm, 31.5 cm

**46935-62**

Tebbetts Brustspatel, Blattbreite 33 mm,  
31,5 cm

Tebbetts Breast spatula, blade width  
33 mm, 31.5 cm

**46935-64**

Tebbetts Brustspatel, Blattbreite 38 mm,  
31,5 cm

Tebbetts Breast spatula, blade width  
38 mm, 31.5 cm



**46935-70**

Agris-Dingman Transaxillary Dissektor,  
rechts gebogen, 36 cm

Agris-Dingman Transaxillary dissector,  
right curved, 36 cm

**46935-72**

Agris-Dingman Transaxillary Dissektor,  
links gebogen, 36 cm

Agris-Dingman Transaxillary dissector,  
left curved, 36 cm



**46935-78**

MacCollum-Dingman Brust Dissektor,  
31,5 cm

MacCollum-Dingman Breast dissector,  
31.5 cm

**46935-80**

MacCollum-Dingman Brust Dissektor,  
41 cm

MacCollum-Dingman Breast dissector,  
41 cm

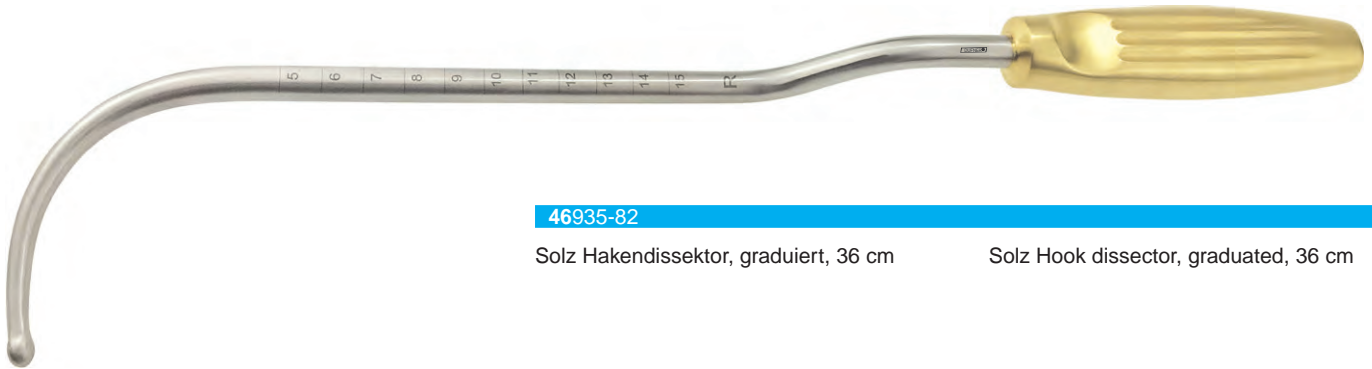

46935-82

Solz Hakendisektor, graduiert, 36 cm

Solz Hook dissector, graduated, 36 cm



46935-84

Solz Brustdissektor, atraumatisch, 34 cm

Solz Breast dissector, atraumatic, 34 cm

46935-85

Solz Brustdissektor, atraumatisch, 37 cm

Solz Breast dissector, atraumatic, 37 cm

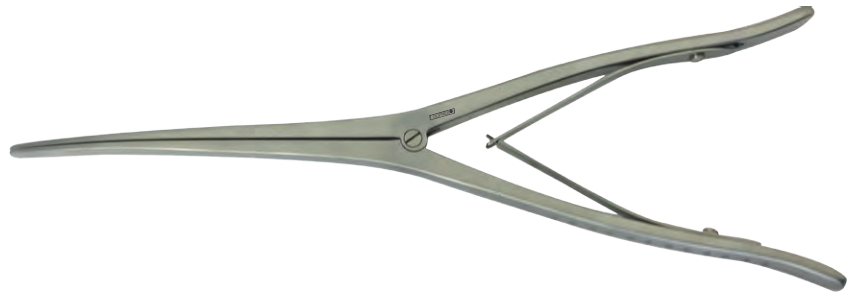

**46932-00**

Brustspreizer klein, Arbeitslänge 8,3 cm,  
22 cm

Breast spreader small, working length  
8.3 cm, 22 cm

**46932-02**

Brustspreizer groß, Arbeitslänge 14,6 cm,  
29,5 cm

Breast spreader large, working length  
14.6 cm, 29.5 cm



**46932-04**

Brustspreizer, Blatt 29 mm diagonal, klein,  
22 cm

Breast spreader, blade 29 mm diagonal,  
small, 22 cm

**46932-06**

Brustspreizer, Blatt 29 mm diagonal, groß,  
29,5 cm

Breast spreader, blade 29 mm diagonal,  
large, 29.5 cm



**46932-08**

Brustheber mit Sperre, 28 cm

Breast elevator with ratchet, 28 cm

**Dissektoren  
Dissectors**



**46929-10**

Daniel Elevator, halb gebogen, Blatt 12,5 mm breit, starr, 24 cm

Daniel Elevator, half curved, blade 12.5 mm wide, rigid, 24 cm



**46929-11**

Daniel Elevator, halb gebogen, Blatt 12,5 mm breit, starr, Ergo-Griff, 26 cm

Daniel Elevator, half curved, blade 12.5 mm wide, rigid, Ergo-handle, 26 cm



**46929-13**

Daniel Elevator, leicht gebogen, Blatt 12,5 mm breit, starr, 24 cm

Daniel Elevator, light curved, blade 12.5 mm wide, rigid, 24 cm



**46929-14**

Daniel Elevator, leicht gebogen, Blatt 12,5 mm breit, starr, Ergo-Griff, 26 cm

Daniel Elevator, light curved, blade 12.5 mm wide, rigid, Ergo-handle, 26 cm



**46929-16**

Daniel Elevator, gerade, Blatt 7 mm breit, starr, 24 cm

Daniel Elevator, straight, blade 7 mm wide, rigid, 24 cm



**46929-17**

Daniel Elevator, gerade, Blatt 7 mm breit, starr, Ergo-Griff, 26 cm

Daniel Elevator, straight, blade 7 mm wide, rigid, Ergo-handle, 26 cm



**46929-19**

Daniel Dissector, leicht gebogen, Blatt 7 mm breit, starr, 24 cm

Daniel Dissector, light curved, blade 7 mm wide, rigid, 24 cm



**46929-20**

Daniel Dissector, leicht gebogen, Blatt 7 mm breit, starr, Ergo-Griff, 26 cm

Daniel Dissector, light curved, blade 7 mm wide, rigid, Ergo-handle, 26 cm



**Dissektoren  
Dissectors**



**46929-22**

Daniel Dissektor, gebogen, Blatt 7 mm breit, starr, 24 cm

Daniel Dissector, curved, blade 7 mm wide, rigid, 24 cm



**46929-23**

Daniel Dissektor, gebogen, Blatt 7 mm breit, starr, Ergo-Griff, 26 cm

Daniel Dissector, curved, blade 7 mm wide, rigid, Ergo-handle, 26 cm



**46929-25**

Daniel Dissektor, stark gebogen, Blatt 7 mm breit, starr, 24 cm

Daniel Dissector, strong curved, blade 7 mm wide, rigid, 24 cm



**46929-26**

Daniel Dissektor, stark gebogen, Blatt 7 mm breit, starr, Ergo-Griff, 26 cm

Daniel Dissector, strong curved, blade 7 mm wide, rigid, Ergo-handle, 26 cm



**46929-28**

Shaper Nervdissektor, scharfe Spitze, leicht gebogen, starr, 24 cm

Shaper Nerv dissector, sharp tip, slightly curved, rigid, 24 cm



**46929-29**

Shaper Nervdissektor, scharfe Spitze, leicht gebogen, starr, Ergo-Griff, 26 cm

Shaper Nerv dissector, sharp tip, slightly curved, rigid, Ergo-handle, 26 cm

**46929-30**

Shaper Nervdissektor, scharfe Spitze, leicht gebogen, biegsam, Ergo-Griff, 26 cm

Shaper Nerv dissector, sharp tip, slightly curved, malleable, Ergo-handle, 26 cm

**Dissektoren  
Dissectors**



**46929-31**

Ramirez Dissektor, gerade, Blatt 10 mm breit, starr, 23,5 cm

Ramirez Dissector, straight, blade 10 mm wide, rigid, 23.5 cm



**46929-32**

Ramirez Dissektor, gerade, Blatt 10 mm breit, starr, Ergo-Griff, 25,5 cm

Ramirez Dissector, straight, blade 10 mm wide, rigid, Ergo-handle, 25.5 cm

**46929-33**

Ramirez Dissektor, gerade, Blatt 10 mm breit, biegsam, Ergo-Griff, 25,5 cm

Ramirez Dissector, straight, blade 10 mm wide, malleable, Ergo-handle, 25.5 cm



**46929-34**

Daniel Dissektor, gebogen, starr, 24 cm

Daniel Dissector, curved, rigid, 24 cm



**46929-35**

Daniel Dissektor, gebogen, starr, Ergo-Griff, 26 cm

Daniel Dissector, curved, rigid, Ergo-handle, 26 cm



**46929-37**

Ramirez Dissektor, S-förmig gebogen, Blatt 12 mm breit, starr, 25 cm

Ramirez Dissector, S-shaped curved, blade 12 mm wide, rigid, 25 cm



**46929-38**

Ramirez Dissektor, S-förmig gebogen, Blatt 12 mm breit, starr, Ergo-Griff, 27 cm

Ramirez Dissector, S-shaped curved, blade 12 mm wide, rigid, Ergo-handle, 27 cm

**46929-39**

Ramirez Dissektor, S-förmig gebogen, Blatt 12 mm breit, biegsam, Ergo-Griff, 27 cm

Ramirez Dissector, S-shaped curved, blade 12 mm wide, malleable, Ergo-handle, 27 cm

**Dissektoren  
Dissectors**



**46929-40**

Shaper Dissektor, leicht gebogen, Blatt 10 mm breit, starr, 22,5 cm

Shaper Dissector, light curved, blade 10 mm wide, rigid, 22.5 cm



**46929-41**

Shaper Dissektor, leicht gebogen, Blatt 10 mm breit, starr, Ergo-Griff, 24 cm

Shaper Dissector, light curved, blade 10 mm wide, rigid, Ergo-handle, 24 cm

**46929-42**

Shaper Dissektor, leicht gebogen, Blatt 10 mm breit, biegsam, Ergo-Griff, 24 cm

Shaper Dissector, light curved, blade 10 mm wide, malleable, Ergo-handle, 24 cm



**46929-43**

Shaper Knochenhaut-Dissektor, S-förmig gebogen, Blatt 5 mm breit, starr, 24 cm

Shaper Periosteal dissector, S-shaped curved, blade 5 mm wide, rigid, 24 cm



**46929-44**

Shaper Knochenhaut-Dissektor, S-förmig gebogen, Blatt 5 mm breit, starr, Ergo-Griff, 26 cm

Shaper Periosteal dissector, S-shaped curved, blade 5 mm wide, rigid, Ergo-handle, 26 cm

**46929-45**

Shaper Knochenhaut-Dissektor, S-förmig gebogen, Blatt 5 mm breit, biegsam, Ergo-Griff, 26 cm

Shaper Periosteal dissector, S-shaped curved, blade 5 mm wide, malleable, Ergo-handle, 26 cm



**46929-46**

Shaper Knochenhaut-Dissektor, S-förmig gebogen, Blatt 8 mm breit, starr, 24 cm

Shaper Periosteal dissector, S-shaped curved, blade 8 mm wide, rigid, 24 cm



**46929-47**

Shaper Knochenhaut-Dissektor, S-förmig gebogen, Blatt 8 mm breit, starr, Ergo-Griff, 26 cm

Shaper Periosteal dissector, S-shaped curved, blade 8 mm wide, rigid, Ergo-handle, 26 cm

**Dissektoren  
Dissectors**



**46929-49**

Shaper Knochenhaut-Dissektor, S-förmig gebogen, Blatt 10 mm breit, starr, 24 cm

Shaper Periosteal dissector, S-shaped curved, blade 10 mm wide, rigid, 24 cm



**46929-50**

Shaper Knochenhaut-Dissektor, S-förmig gebogen, Blatt 10 mm breit, starr, Ergo-Griff, 26 cm

Shaper Periosteal dissector, S-shaped curved, blade 10 mm wide, rigid, Ergo-handle, 26 cm



**46929-52**

Shaper Dissektor, leicht gebogen, starr, 22,5 cm

Shaper Dissector, light curved, rigid, 22.5 cm



**46929-54**

Shaper Dissektor, leicht gebogen, starr, Ergo-Griff, 24,5 cm

Shaper Dissector, light curved, rigid, Ergo-handle, 24.5 cm



**46929-56**

Shaper Dissektor, gerade, Blatt 5 mm breit, starr, 24 cm

Shaper Dissector, straight, blade 5 mm wide, rigid, 24 cm



**46929-57**

Shaper Dissektor, gerade, Blatt 5 mm breit, starr, Ergo-Griff, 26 cm

Shaper Dissector, straight, blade 5 mm wide, rigid, Ergo-handle, 26 cm



**46929-59**

Shaper Dissektor, gerade, Blatt 7 mm breit, starr, 24 cm

Shaper Dissector, straight, blade 7 mm wide, rigid, 24 cm



**46929-60**

Shaper Dissektor, gerade, Blatt 7 mm breit, starr, Ergo-Griff, 26 cm

Shaper Dissector, straight, blade 7 mm wide, rigid, Ergo-handle, 26 cm

**Dissektoren  
Dissectors**



**46929-62**

Shaper Dissektor, gerade, Blatt 10 mm  
breit, starr, 24 cm

Shaper Dissector, straight, blade 10 mm  
wide, rigid, 24 cm



**46929-63**

Shaper Dissektor, gerade, Blatt 10 mm  
breit, starr, Ergo-Griff, 26 cm

Shaper Dissector, straight, blade 10 mm  
wide, rigid, Ergo-handle, 26 cm



**46929-65**

Shaper Dissektor, leicht gebogen,  
Blatt 5 mm breit, starr, 24 cm

Shaper Dissector, light curved, blade 5 mm  
wide, rigid, 24 cm



**46929-66**

Shaper Dissektor, leicht gebogen,  
Blatt 5 mm breit, starr, Ergo-Griff, 26 cm

Shaper Dissector, light curved, blade 5 mm  
wide, rigid, Ergo-handle, 26 cm



**46929-68**

Shaper Dissektor, leicht gebogen,  
Blatt 7 mm breit, starr, 24 cm

Shaper Dissector, light curved, blade 7 mm  
wide, rigid, 24 cm



**46929-69**

Shaper Dissektor, leicht gebogen,  
Blatt 7 mm breit, starr, Ergo-Griff, 26 cm

Shaper Dissector, light curved, blade 7 mm  
wide, rigid, Ergo-handle, 26 cm



**46929-71**

Shaper Dissektor, leicht gebogen,  
Blatt 10 mm breit, starr, 24 cm

Shaper Dissector, light curved, blade  
10 mm wide, rigid, 24 cm



**46929-72**

Shaper Dissektor, leicht gebogen,  
Blatt 10 mm breit, starr, Ergo-Griff, 26 cm

Shaper Dissector, light curved, blade  
10 mm wide, rigid, Ergo-handle, 26 cm



**46929-74**

Stirnbein Dissektor, S-förmig gebogen, Blatt 7 mm breit, starr, 26,5 cm

Shaper Frontoglabellar dissector, S-shaped curved, blade 7 mm wide, rigid, 26.5 cm

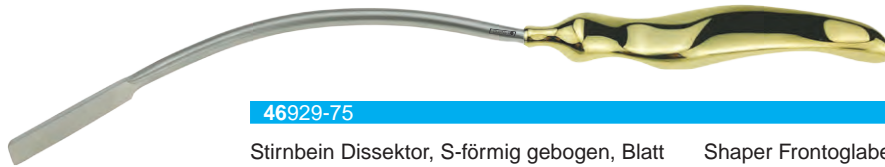

**46929-75**

Stirnbein Dissektor, S-förmig gebogen, Blatt 7 mm breit, starr, Ergo-Griff, 28,5 cm

Shaper Frontoglabellar dissector, S-shaped curved, blade 7 mm wide, rigid, Ergo-handle, 28.5 cm

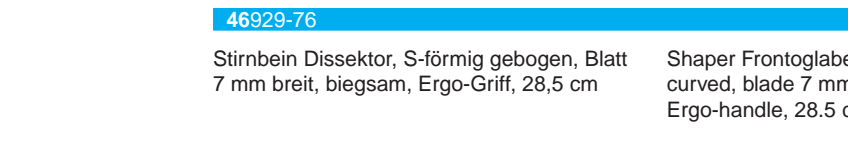

**46929-76**

Stirnbein Dissektor, S-förmig gebogen, Blatt 7 mm breit, biegsam, Ergo-Griff, 28,5 cm

Shaper Frontoglabellar dissector, S-shaped curved, blade 7 mm wide, malleable, Ergo-handle, 28.5 cm



**46929-77**

Shaper Transoraler Dissektor, gebogen, Blatt 7 mm breit, starr, 23,5 cm

Shaper Transoral dissector, curved, blade 7 mm wide, rigid, 23.5 cm



**46929-78**

Shaper Transoraler Dissektor, gebogen, Blatt 7 mm breit, starr, Ergo-Griff, 25,5 cm

Shaper Transoral dissector, curved, blade 7 mm wide, rigid, Ergo-handle, 25.5 cm



**46929-80**

Shaper Nerven Dissektor, leicht gebogen, starr, 24 cm

Shaper Nerve dissector, light curved, rigid, 24 cm



**46929-81**

Shaper Nerven Dissektor, leicht gebogen, starr, Ergo-Griff, 26 cm

Shaper Nerve dissector, light curved, rigid, Ergo-handle, 26 cm

**Dissektoren  
Dissectors**



**46929-83**

Shaper Nerven Haken, gebogen rechts,  
24 cm

Shaper Nerve hook, curved right, 24 cm



**46929-84**

Shaper Nerven Haken, gebogen rechts,  
Ergo-Griff, 26 cm

Shaper Nerve hook, curved right,  
Ergo-handle, 26 cm



**46929-86**

Shaper Nerven Haken, gebogen links,  
24 cm

Shaper Nerve hook, curved left, 24 cm



**46929-87**

Shaper Nerven Haken, gebogen links,  
Ergo-Griff, 26 cm

Shaper Nerve hook, curved left,  
Ergo-handle, 26 cm



**46929-89**

Daniel Saugellevator 8 mm, 26 cm

Daniel Suction elevator, 8 mm, 26 cm



**46929-90**

Daniel Saugellevator mit Loch, 8 mm, 26 cm

Daniel Suction elevator, with a hole, 8 mm,  
26 cm

**Dissektoren  
Dissectors**



**46942-04**

Ramirez Nerven Protektor, gebogen links,  
17 cm

Ramirez Nerve protector, curved left, 17 cm



**46942-06**

Ramirez Nerven Protektor, gebogen rechts,  
17 cm

Ramirez Nerve protector, curved right,  
17 cm



**46942-08**

Ramirez Nerven Messer, 3 mm, 17 cm

Ramirez Nerve cutting knife, 3 mm, 17 cm



**46942-10**

Ramirez Muskel Dissektor, 5 mm, 19,5 cm

Ramirez Procerus dissector, 5 mm, 19.5 cm



**46942-14**

Skalpellgriff, abgewinkelt, 20,5 cm

Scalpel handle, angled downwards, 20.5 cm



**46942-16**

Nerven Haken stumpf, starr, 24 cm

Nerve hook, blunt, rigid, 24 cm

**46942-18**

Nerven Haken stumpf, biegsam, 24 cm

Nerve hook, blunt, malleable, 24 cm



**46942-20**

Nerven Haken stumpf, biegsam, graduiert,  
23,5 cm

Nerve hook, blunt, malleable, graduated,  
23.5 cm





**46947-12**

Monopolare Saug-Spülelektrode nach unten gebogen, Ø 5,0 mm, 150 mm lang





Monopolar suction/irrigation electrode curved downwards, Ø 5.0 mm, 150 mm long

Für Elektrode 46947-12  
For electrode 46947-12

Instrumentenseitig  
Instrument site



Geräteseitig  
Unit site

Monopolare Kabel	Länge	
Monopolar Cable	Length	
 Erbe T-Serie, Storz, Wolf	4,5 m	26944-01
 Erbe ACC, ICC, VIO	4,5 m	26944-02
 Valleylab, Conmed, Bovie	4,5 m	26944-03
 Martin, Berchtold, Aescutap	4,5 m	26944-04



**46915-06**

Endoskop Schutzhülse, Arbeitslänge 40 mm

Endoscope safety shaft, 40 mm working length

**Nasenraspeln  
Nose Rasp**

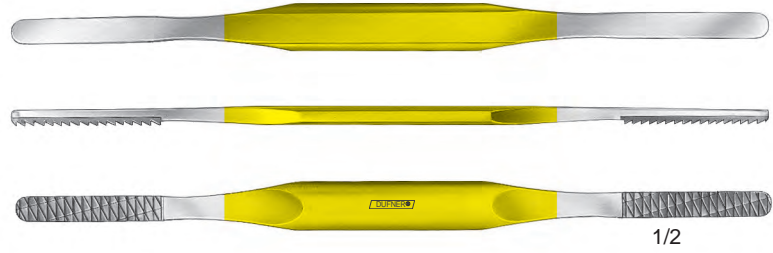
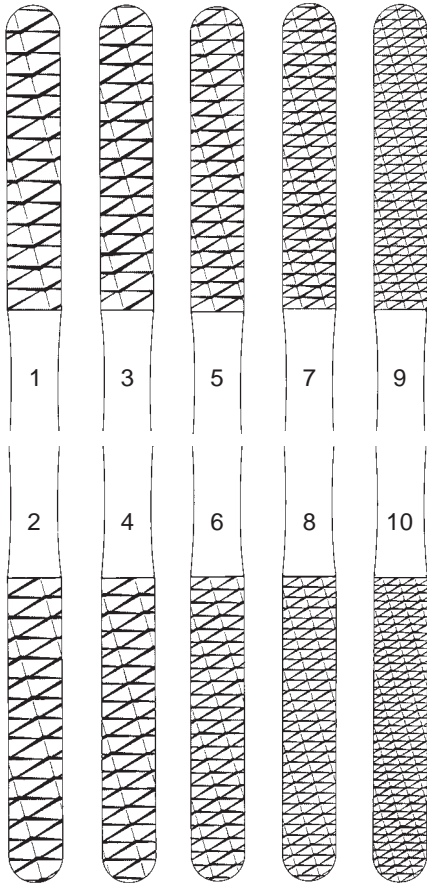

**44654-01**

Fomon Nasenraspel Figur 1/2, 20,0 cm,  
Top dur

Fomon nose rasp figure 1/2, 20.0 cm,  
Top dur

**44654-02**

Fomon Nasenraspel Figur 3/4, 20,0 cm,  
Top dur

Fomon nose rasp figure 3/4, 20.0 cm,  
Top dur

**44654-03**

Fomon Nasenraspel Figur 5/6, 20,0 cm,  
Top dur

Fomon nose rasp figure 5/6, 20.0 cm,  
Top dur

**44654-04**

Fomon Nasenraspel Figur 7/8, 20,0 cm,  
Top dur

Fomon nose rasp figure 7/8, 20.0 cm,  
Top dur

**44654-05**

Fomon Nasenraspel Figur 9/10, 20,0 cm,  
Top dur

Fomon nose rasp figure 9/10, 20.0 cm,  
Top dur

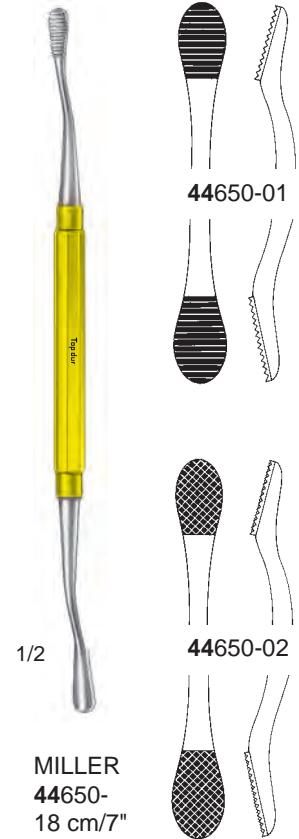
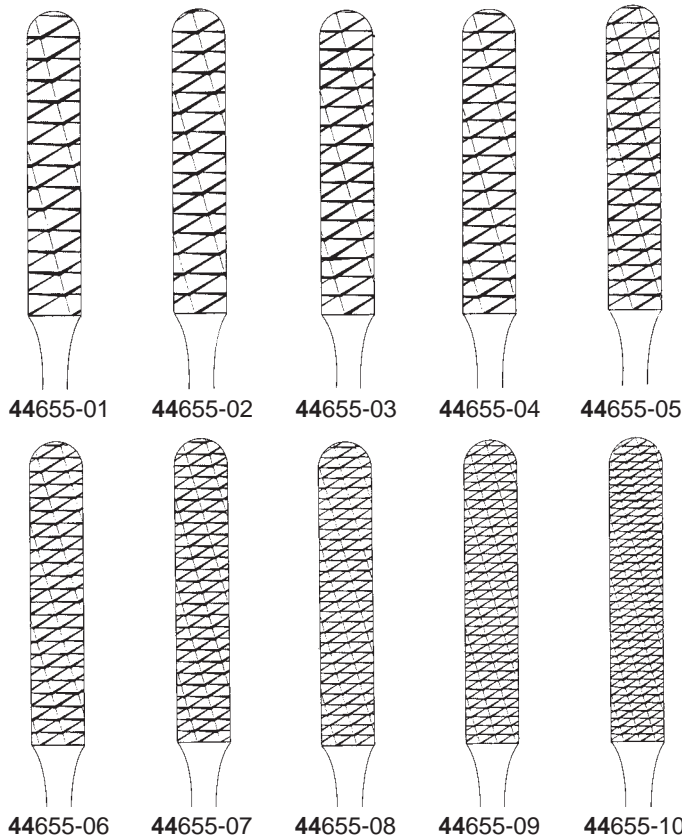



44638-01

Aufricht Glabella Nasenraspel, Top dur,  
gerade, gewölbte Spitze, 19 cm

Aufricht Glabella Nose rasp, Top dur,  
straight, convex tip, 19 cm

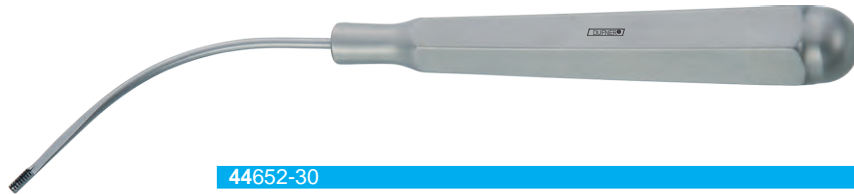

44652-30

Dingman Knorpelschaber, links, 15 cm

Dingman Cartilage abraders, left, 15 cm



44652-32

Dingman Knorpelschaber, rechts, 15 cm

Dingman Cartilage abraders, right, 15 cm



26903-25

MICTEC Aufbewahrungsbox für Endoskope,  
Kunststoff, 250 mm lang

MICTEC Container for endoscopes, plastic,  
250 mm long



26903-29

MICTEC Aufbewahrungsbox für Endoskope,  
Metall, 290 mm lang

MICTEC Container for endoscopes, metal,  
290 mm long



**44591-02**

Rees Nasenmeißel, gerade, 2 mm  
breit, 20 cm

Rees Nasal Osteotome, straight,  
2 mm wide, 20 cm

**44591-03**

Rees Nasenmeißel, gerade, 3 mm  
breit, 20 cm

Rees Nasal Osteotome, straight,  
3 mm wide, 20 cm

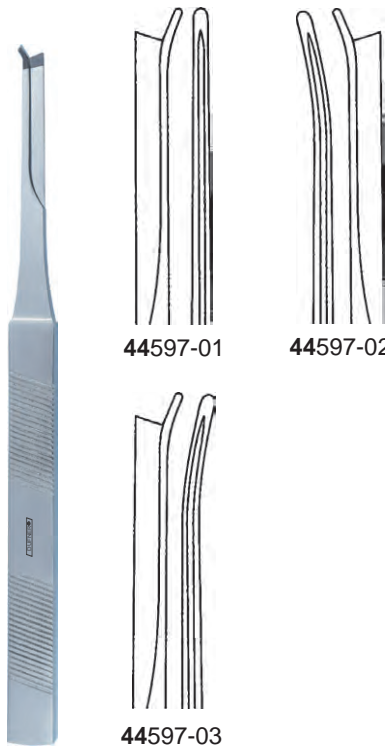

44597-01

44597-02

44597-03

**44597-01**

Silver Nasenmeißel, gerade, 18 cm

Silver Nasal Osteotome, straight,  
18 cm

**44597-02**

Silver Nasenmeißel, rechts, 18 cm

Silver Nasal Osteotome, right, 18 cm

**44597-03**

Silver Nasenmeißel, links, 18 cm

Silver Nasal Osteotome, left, 18 cm



**44597-10**

Parkes Nasenmeißel, 5 mm breit,  
18 cm

Parkes Nasal Osteotome, 5 mm wide,  
18 cm



**44622-00**

Cottle Knorpelquetscher, glatt, mit  
Entnahmeklammer, 60 x 30 x 30 mm

Cottle Cartilage Crusher, smooth,  
with clamp for removal of prepared  
material, 60 x 30 x 30 mm



**44622-01**

Jost Knorpelquetscher, gerieft,  
60 x 30 mm

Jost Cartilage Crusher, serrated,  
60 x 30 mm

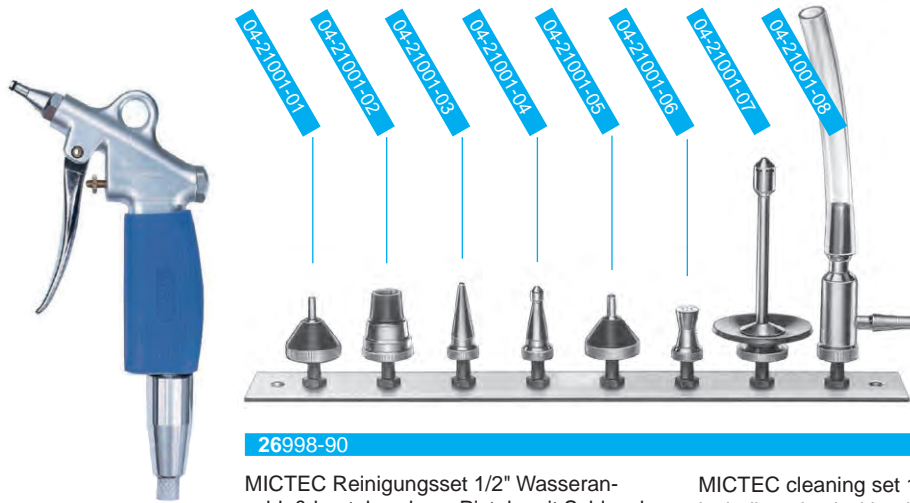

**26998-90**

MICTEC Reinigungsset 1/2" Wasseranschluß bestehend aus Pistole mit Schlauch, 8 Adaptern, Befestigungshalterung für Adapter

MICTEC cleaning set 1/2" water connection including pistol with tube, 8 adapters, fixation for adapter



**26998-95**

MICTEC Bürste, Ø 2 mm, 360 mm Arbeitslänge

MICTEC brush, Ø 2 mm, 360 mm working length



**26998-96**

MICTEC Bürste, Ø 3 mm, 360 mm Arbeitslänge

MICTEC brush, Ø 5 mm, 430 mm working length



**26998-91**

MICTEC Bürste, Ø 5 mm, 430 mm Arbeitslänge

MICTEC brush, Ø 5 mm, 430 mm working length



**26998-94**

MICTEC Bürste, Ø 10 mm, 430 mm Arbeitslänge

MICTEC brush, Ø 10 mm, 430 mm working length



Technische Änderungen vorbehalten. Dieser Prospekt darf ausschließlich zur Anbietung und dem An- und Verkauf unserer Produkte dienen. Reproduktion, auch auszugsweise, durch irgendeine Form (z.B. Fotokopie, elektronische Verfahren oder andere Arten der Vervielfältigung), ist verboten und bedarf der schriftlichen Genehmigung unseres Hauses. Bei Mißbrauch behalten wir uns Regreßmaßnahmen vor.

Subject to technical modifications. This catalogue to be used for no other purpose than offering, buying and selling of our products. Reprinting, ever partially, by any means (e.g. electronic, mechanical, photocopying or others) is not allowed and need our prior written permission. By misuse we reserve the right for recourse measures.



DUFNER  
 Instrumente GmbH  
 Fabrik ärztlicher Instrumente  
 Medizintechnik  
 Föhrenstraße 9  
 D-78532 Tuttlingen  
 Telefon +49(0)74 61-3697  
 E-mail: info@dufner-tuttlingen.de  
 www.dufner-tuttlingen.de

DUFNER trade marks

- TOP DUR**  
Tungsten carbide instruments
- DIRONDAL**  
Round edge needle holders
- DIMICRON**  
Needle holders with micro spray tip
- IPERCUT**  
Scissors with 2 different cutting edges
- MICTEC**  
Instrumental equipment for MIS
- MICASEPT®**  
Compact MIS instruments
- CLICASEPT**  
Modular MIS instruments
- DIROVISION**  
Endoscopic camera systems
- DIROLIGHT**  
Cold light sources
- DIROFLATOR**  
Insufflation units
- DILAVATOR**  
Suction/irrigation units
- CIRADUR**  
Hard surface instruments
- DICRATEC**  
Instruments for ambitious surgery

DUFNER bietet Qualitätsinstrumente für die verschiedensten chirurgischen Fachgebiete. Fordern Sie bitte unsere Spezialkataloge an.

DUFNER offers quality instruments for different surgical fields. Please contact us and order our special catalogues.

